



INFORMAZIONI TECNICHE

Struttura: 1-2-6

Masselli portanti in abete di vari spessori. Fianchi di tamponamento in pannelli di particelle di legno in classe E1, particolari in pannelli di fibra di legno dura.

Struttura rivestita completamente in lastre di poliuretano espanso e Tecnoform.

Molleggio: 8

Seduta in nastri elastici di fibra propilenica e lattice.

Imbottiture: 2-3-4-5-6-10-11

Cuscini schienale in poliuretano espanso indeformabile densità 75 kg/m³ e 25 kg/m³ rivestiti in piuma d'oca con zavorra in metallo. Cuscini schienale fantasma in chips di polistirene misto a fibra di poliestere in fiocco con leggera zavorra in metallo.

Cuscini seduta in poliuretano espanso indeformabile densità 35 kg/m³ rivestiti in Tecnoform e vera piuma d'oca.

Rivestimento: 7

In tessuto completamente sfoderabile. Basi e schienali non disponibili in similpelle o pelle. Negli schienali sono disponibili, con maggiorazione, specchi in pelle o tessuto con trapuntatura eleganza.

Per versione bicolore nelle basi specificare i colori del rivestimento superiore e inferiore. Cerniera disponibile in due colori, beige (CE01) e grigio (CE03).

Su richiesta disponibili basi e schienali senza cerniera.

Piedini: 9

Piedini in ABS di colore nero.

L'ordine di ogni composizione deve sempre essere corredato da un disegno in pianta.

Dimensioni:

Altezza seduta da terra cm. 41

Altezza piedino cm. 6

TECHNICAL INFORMATION

Structure: 1-2-6

Supporting structure in pinewood of various thicknesses. Remaining parts in Class E1 wood particleboard panels, details in hard wood-based panels. Structure completely covered with foam and Tecnoform.

Springing: 8

The seat is supported by propylene and latex elastic belts.

Cushions Padding: 2-3-4-5-6-10-11

Back cushions in form-stable expanded polyurethane, density 75 kg/m³ and 25 kg/m³, upholstered in goose down with metal weight. Low-cut back cushions in polystyrene chips mixed with polyester fibre batting, with a light metal weight.

Seat cushions in non-deformable polyurethane foam, density 35 kg/cbm, Tecnoform and down covered.

Cover: 7

Fabric upholstery fully removable. Bases and backrests not available in leatherette or leather. The backrests are available, at a surcharge, with mirror-image leather or fabric upholstery with Elegance quilting.

For double colour bases, please specify both covers' colour. Zip available in two colours, beige (CE01) and grey (CE03). Bases and back cushions available without zip on request.

Feet: 9

Black ABS feet.

For orders of compositions a sketch is requested.

Dimensions:

Seat height from ground cm. 41

Feet height cm. 6

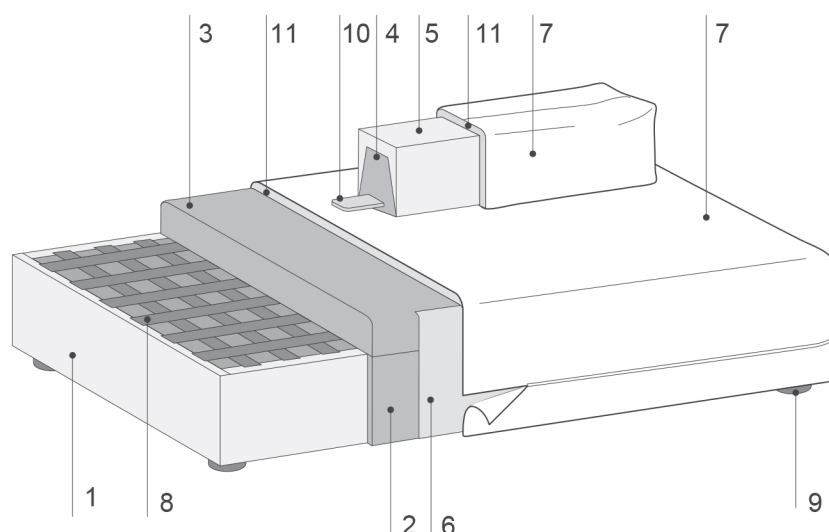

Sanders elementi con schienali con cerniera zip - Sanders elements with back cushions with zip

Composizione rettangolare 174

Rectangular composition 174

Cod. C2R00

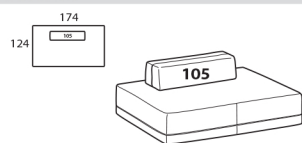

↔ 174cm ↘ 124cm ↓ 73cm
 ☐ 1,21 m³ ⚖ 67kg ⚙ 5,1mt+2,6mt

Per finitura bicolore prezzo della categoria più alta dei rivestimenti utilizzati.
 For the two-coloured version pls. consider the price of the highest category of fabrics

Composizione elemento quadro

Squared composition

Cod. C1Q00

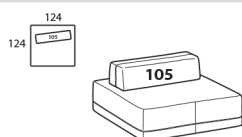

↔ 124cm ↘ 124cm ↓ 73cm
 ☐ 0,95 m³ ⚖ 58kg ⚙ 3,4mt+1,8mt

Per finitura bicolore prezzo della categoria più alta dei rivestimenti utilizzati.
 For the two-coloured version pls. consider the price of the highest category of fabrics

Composizione angolare SX

Left angular composition

Cod. C1F00S

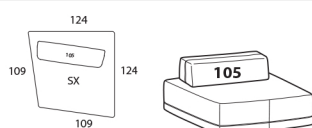

↔ 124cm ↘ 124cm ↓ 73cm
 ☐ 1,07 m³ ⚖ 53kg ⚙ 3,4mt+1,8mt

Per finitura bicolore prezzo della categoria più alta dei rivestimenti utilizzati.
 For the two-coloured version pls. consider the price of the highest category of fabrics

Composizione per bracciolo SX

Element with back cushion for left armrest

Cod. C1D00S

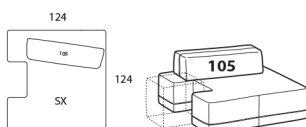

↔ 124cm ↘ 124cm ↓ 73cm
 ☐ 0,95 m³ ⚖ 55kg ⚙ 3,5mt+2,2mt

Per finitura bicolore prezzo della categoria più alta dei rivestimenti utilizzati.
 For the two-coloured version pls. consider the price of the highest category of fabrics

Composizione rettangolare 199

Rectangular composition 199

Cod. C2R0G

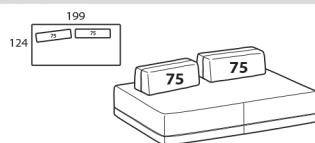

↔ 199cm ↘ 124cm ↓ 73cm
 ☐ 1,45 m³ ⚖ 83kg ⚙ 6,7mt+2,6mt

Per finitura bicolore prezzo della categoria più alta dei rivestimenti utilizzati.
 For the two-coloured version pls. consider the price of the highest category of fabrics

Composizione angolare DX

Right angular composition

Cod. C1F00D

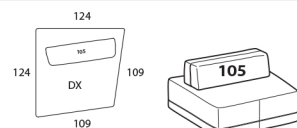

↔ 124cm ↘ 124cm ↓ 73cm
 ☐ 1,07 m³ ⚖ 53kg ⚙ 3,4mt+1,8mt

Per finitura bicolore prezzo della categoria più alta dei rivestimenti utilizzati.
 For the two-coloured version pls. consider the price of the highest category of fabrics

Composizione per bracciolo DX

Element with back cushion for right armrest

Cod. C1D00D

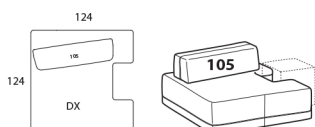

↔ 124cm ↘ 124cm ↓ 73cm
 ☐ 0,95 m³ ⚖ 55kg ⚙ 3,5mt+2,2mt

Per finitura bicolore prezzo della categoria più alta dei rivestimenti utilizzati.
 For the two-coloured version pls. consider the price of the highest category of fabrics

Composizione rettangolare 224

Rectangular composition 224

Cod. C3R00

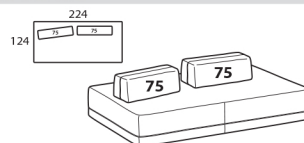

↔ 224cm ↘ 124cm ↓ 73cm
 ☐ 1,62 m³ ⚖ 90kg ⚙ 6,7mt+2,6mt

Per finitura bicolore prezzo della categoria più alta dei rivestimenti utilizzati.
 For the two-coloured version pls. consider the price of the highest category of fabrics

Composizione a trapezio frontale LARGO

Large trapezoidal composition

Cod. C1H00L

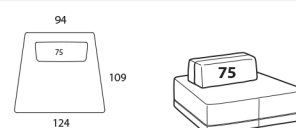

↔ 124cm ↘ 109cm ↓ 73cm
 ☐ 1,01 m³ ⚖ 47kg ⚙ 3,2mt+1,8mt

Per finitura bicolore prezzo della categoria più alta dei rivestimenti utilizzati.
 For the two-coloured version pls. consider the price of the highest category of fabrics

Bracciolo da incasso

Recessed armrest

Cod. ZB0IL

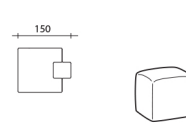

↔ 53cm ↘ 48cm ↓ 52cm
 ☐ 0,13 m³ ⚖ 10kg ⚙ 1,4mt

Composizione rettangolare 249

Rectangular composition 249

Cod. C3R0M

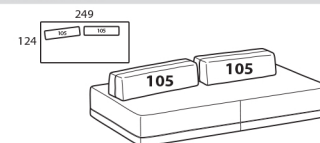

↔ 249cm ↘ 124cm ↓ 73cm
 ☐ 1,85 m³ ⚖ 104kg ⚙ 6,7mt+3,2mt

Per finitura bicolore prezzo della categoria più alta dei rivestimenti utilizzati.
 For the two-coloured version pls. consider the price of the highest category of fabrics

Bracciolo profondità 124

Armrest depth 124

Cod. (<--> ZB004S - ZB004D (<-->)

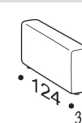

↔ 32cm ↘ 124cm ↓ 56cm
 ☐ 0,23 m³ ⚖ 24kg ⚙ 2,2mt

Composizione a trapezio frontale STRETTO

Tight trapezoidal composition

Cod. C1H00S

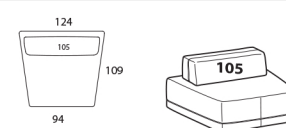

↔ 124cm ↘ 109cm ↓ 73cm
 ☐ 1,07 m³ ⚖ 51kg ⚙ 3,2mt+1,8mt

Per finitura bicolore prezzo della categoria più alta dei rivestimenti utilizzati.
 For the two-coloured version pls. consider the price of the highest category of fabrics

Sanders elementi profondita' 109 con schienali con cerniera zip - Sanders elements width 109 with back cushions with zip

Composizione rettangolare 174 profondita' 109

Rectangular composition 174, 109 cm depth

Cod. C2R10

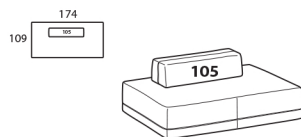

↔ 174cm ↘ 109cm ↓ 73cm
 ☐ 1,21 m² △ 61kg ↻ 6,1mt+1,4mt

Per finitura bicolore prezzo della categoria più alta dei rivestimenti utilizzati.
 For the two-coloured version pls. consider the price of the highest category of fabrics

Composizione elemento quadro profondita' 109

Squared composition, 109 cm depth

Cod. C1Q10

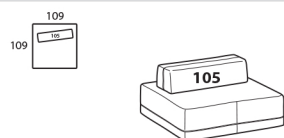

↔ 109cm ↘ 109cm ↓ 73cm
 ☐ 0,95 m² △ 52kg ↻ 4,2mt+1,4mt

Per finitura bicolore prezzo della categoria più alta dei rivestimenti utilizzati.
 For the two-coloured version pls. consider the price of the highest category of fabrics

Composizione rettangolare 199 profondita' 109

Rectangular composition 199, 109 cm depth

Cod. C2RIG

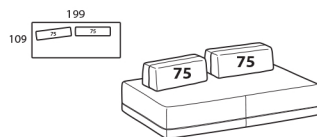

↔ 199cm ↘ 109cm ↓ 73cm
 ☐ 1,45 m² △ 76kg ↻ 7,8mt+1,4mt

Per finitura bicolore prezzo della categoria più alta dei rivestimenti utilizzati.
 For the two-coloured version pls. consider the price of the highest category of fabrics

Composizione rettangolare 224 profondita' 109

Rectangular composition 224, 109 cm depth

Cod. C3R10

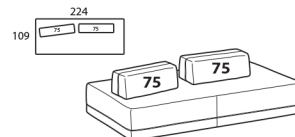

↔ 224cm ↘ 109cm ↓ 73cm
 ☐ 1,62 m² △ 83kg ↻ 7,8mt+1,4mt

Per finitura bicolore prezzo della categoria più alta dei rivestimenti utilizzati.
 For the two-coloured version pls. consider the price of the highest category of fabrics

Composizione rettangolare 249 profondita' 109

Rectangular composition 249, 109 cm depth

Cod. C3RIM

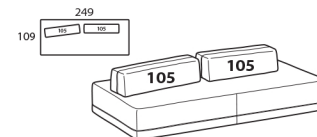

↔ 249cm ↘ 109cm ↓ 73cm
 ☐ 1,85 m² △ 95kg ↻ 7,8mt+1,4mt

Per finitura bicolore prezzo della categoria più alta dei rivestimenti utilizzati.
 For the two-coloured version pls. consider the price of the highest category of fabrics

Bracciolo profondita' 109

Armrest depth 109

Cod. (<--> ZB002S - ZB002D (<-->)



↔ 32cm ↘ 109cm ↓ 56cm
 ☐ 0,2 m² △ 19kg ↻ 2,0mt

Sanders basi - Sanders bases

Base rettangolare 174

Rectangular base 174

Cod. U2R00

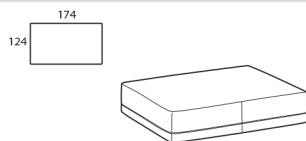

↔ 174cm ↘ 124cm ↓ 41cm
 ☐ 0,99 m³ △ 49kg ⚡ 3,5mt+2,6mt

Per finitura bicolore prezzo della categoria più alta dei rivestimenti utilizzati.
 For the two-coloured version pls. consider the price of the highest category of fabrics

Base quadra

Square base

Cod. U1Q00



↔ 124cm ↘ 124cm ↓ 41cm
 ☐ 0,73 m³ △ 39kg ⚡ 1,8mt+1,8mt

Per finitura bicolore prezzo della categoria più alta dei rivestimenti utilizzati.
 For the two-coloured version pls. consider the price of the highest category of fabrics

Base per bracciolo SX

Base for left armrest

Cod. U1D00S

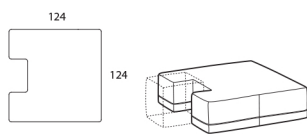

↔ 124cm ↘ 124cm ↓ 41cm
 ☐ 0,73 m³ △ 36kg ⚡ 1,9mt+2,2mt

Per finitura bicolore prezzo della categoria più alta dei rivestimenti utilizzati.
 For the two-coloured version pls. consider the price of the highest category of fabrics

Base angolare SX

Left corner base

Cod. U1F00S

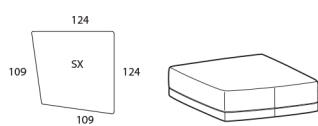

↔ 124cm ↘ 124cm ↓ 41cm
 ☐ 0,85 m³ △ 35kg ⚡ 1,8mt+1,8mt

Per finitura bicolore prezzo della categoria più alta dei rivestimenti utilizzati.
 For the two-coloured version pls. consider the price of the highest category of fabrics

Base rettangolare 199

Rectangular base 199

Cod. U2R0G

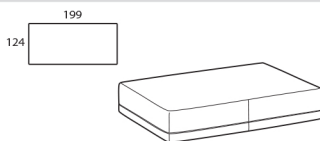

↔ 199cm ↘ 124cm ↓ 41cm
 ☐ 1,13 m³ △ 55kg ⚡ 3,5mt+2,6mt

Per finitura bicolore prezzo della categoria più alta dei rivestimenti utilizzati.
 For the two-coloured version pls. consider the price of the highest category of fabrics

Base per bracciolo DX

Base for right armrest

Cod. U1D00D

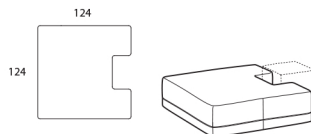

↔ 124cm ↘ 124cm ↓ 41cm
 ☐ 0,73 m³ △ 36kg ⚡ 1,9mt+2,2mt

Per finitura bicolore prezzo della categoria più alta dei rivestimenti utilizzati.
 For the two-coloured version pls. consider the price of the highest category of fabrics

Base angolare DX

Right corner base

Cod. U1F00D

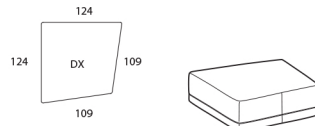

↔ 124cm ↘ 124cm ↓ 41cm
 ☐ 0,85 m³ △ 35kg ⚡ 1,8mt+1,8mt

Per finitura bicolore prezzo della categoria più alta dei rivestimenti utilizzati.
 For the two-coloured version pls. consider the price of the highest category of fabrics

Base rettangolare 224

Rectangular base 224

Cod. U3R00

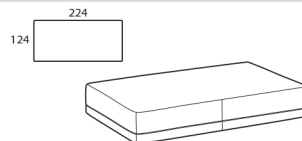

↔ 224cm ↘ 124cm ↓ 41cm
 ☐ 1,30 m³ △ 62kg ⚡ 3,5mt+2,6mt

Per finitura bicolore prezzo della categoria più alta dei rivestimenti utilizzati.
 For the two-coloured version pls. consider the price of the highest category of fabrics

Bracciolo da incasso

Recessed armrest

Cod. ZB0IL

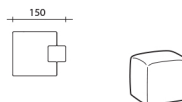

↔ 53cm ↘ 48cm ↓ 52cm
 ☐ 0,13 m³ △ 10kg ⚡ 1,4mt

Base a trapezio frontale LARGO

Large trapezoidal base

Cod. U1H00L

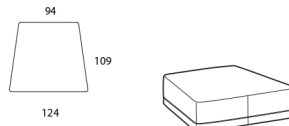

↔ 124cm ↘ 109cm ↓ 41cm
 ☐ 0,85 m³ △ 33kg ⚡ 1,6mt+1,8mt

Per finitura bicolore prezzo della categoria più alta dei rivestimenti utilizzati.
 For the two-coloured version pls. consider the price of the highest category of fabrics

Base rettangolare 249

Rectangular base 249

Cod. U3R0M



↔ 249cm ↘ 124cm ↓ 41cm
 ☐ 1,41 m³ △ 67kg ⚡ 3,5mt+3,2mt

Per finitura bicolore prezzo della categoria più alta dei rivestimenti utilizzati.
 For the two-coloured version pls. consider the price of the highest category of fabrics

Bracciolo profondita' 124

Armrest depth 124

Cod. (<--> ZB004S - ZB004D (<-->)

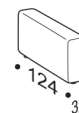

↔ 32cm ↘ 124cm ↓ 56cm
 ☐ 0,23 m³ △ 24kg ⚡ 2,2mt

Base a trapezio frontale STRETTO

Tight trapezoidal base

Cod. U1H00S

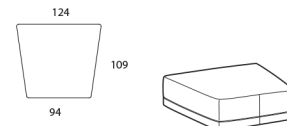

↔ 124cm ↘ 109cm ↓ 41cm
 ☐ 0,85 m³ △ 33kg ⚡ 1,6mt+1,8mt

Per finitura bicolore prezzo della categoria più alta dei rivestimenti utilizzati.
 For the two-coloured version pls. consider the price of the highest category of fabrics

Sanders basi profondita' 109 - Sanders bases width 109

Base rettangolare 174 profondita' 109

Rectangular base 174 width 109

Cod. U2RIO

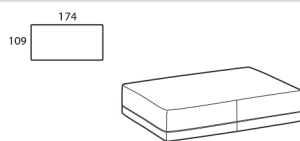

↔ 174cm ↘ 109cm ↓ 41cm
 ☐ 0,99 m³ ⚖ 43kg ⚙ 4,6mt+1,4mt

Per finitura bicolore prezzo della categoria più alta dei rivestimenti utilizzati.
 For the two-coloured version pls. consider the price of the highest category of fabrics

Base quadra 109 profondita' 109

Square base 109 width 109

Cod. U1QIO

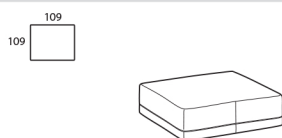

↔ 109cm ↘ 109cm ↓ 41cm
 ☐ 0,73 m³ ⚖ 34kg ⚙ 2,6mt+1mt

Per finitura bicolore prezzo della categoria più alta dei rivestimenti utilizzati.
 For the two-coloured version pls. consider the price of the highest category of fabrics

Base rettangolare 199 profondita' 109

Rectangular base 199 width 109

Cod. U2RIG

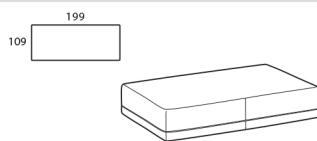

↔ 199cm ↘ 109cm ↓ 41cm
 ☐ 1,13 m³ ⚖ 48kg ⚙ 4,6mt+1,4mt

Per finitura bicolore prezzo della categoria più alta dei rivestimenti utilizzati.
 For the two-coloured version pls. consider the price of the highest category of fabrics

Base rettangolare 224 profondita' 109

Rectangular base 224 width 109

Cod. U3RIO

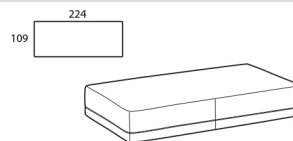

↔ 224cm ↘ 109cm ↓ 41cm
 ☐ 1,3 m³ ⚖ 55kg ⚙ 4,6mt+1,4mt

Per finitura bicolore prezzo della categoria più alta dei rivestimenti utilizzati.
 For the two-coloured version pls. consider the price of the highest category of fabrics

Base rettangolare 249 profondita' 109

Rectangular base 249 depth 109

Cod. U3RIM

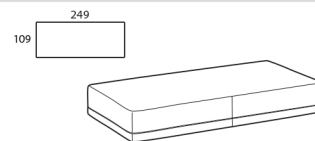

↔ 249cm ↘ 109cm ↓ 41cm
 ☐ 1,41 m³ ⚖ 59kg ⚙ 4,6mt+1,4mt

Per finitura bicolore prezzo della categoria più alta dei rivestimenti utilizzati.
 For the two-coloured version pls. consider the price of the highest category of fabrics

Bracciolo profondita' 109

Armrest depth 109

Cod. (<-->) ZB002S - ZB002D (<-->)

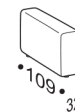

↔ 32cm ↘ 109cm ↓ 56cm
 ☐ 0,2 m³ ⚖ 19kg ⚙ 2,0mt

Sanders schienali - Sanders back cushions

Schienale liscio da cm 75 con cerniera zip

Smooth back cushion 75 with zip

Cod. ZH075



↔ 75cm ↘ 33cm ↓ 35cm
📦 0,13 m³ ⚖ 15kg 🌀 1,6mt

Per finitura bicolore prezzo della categoria più alta dei rivestimenti utilizzati.
For the two-coloured version pls. consider the price of the highest category of fabrics

Schienale liscio da cm 105 con cerniera zip

Smooth back cushion 105 with zip

Cod. ZH105



↔ 105cm ↘ 33cm ↓ 35cm
📦 0,17 m³ ⚖ 15kg 🌀 1,6mt

Per finitura bicolore prezzo della categoria più alta dei rivestimenti utilizzati.
For the two-coloured version pls. consider the price of the highest category of fabrics

Schienale aggiuntivo con poggiatesta

Additional back cushion with headrest

Cod. ZCS11

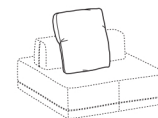

↔ 64cm ↘ 18-25cm ↓ 66cm
📦 0,15 m³ ⚖ 5kg 🌀 2,0mt

Schienale liscio da cm 75 senza cerniera zip

Smooth back cushion 75 without zip

Cod. ZS075



↔ 75cm ↘ 33cm ↓ 35cm
📦 0,13 m³ ⚖ 15kg 🌀 1,6mt

Per finitura bicolore prezzo della categoria più alta dei rivestimenti utilizzati.
For the two-coloured version pls. consider the price of the highest category of fabrics

Schienale liscio da cm 105 senza cerniera zip

Smooth back cushion 105 without zip

Cod. ZS105



↔ 105cm ↘ 33cm ↓ 35cm
📦 0,17 m³ ⚖ 15kg 🌀 1,6mt

Per finitura bicolore prezzo della categoria più alta dei rivestimenti utilizzati.
For the two-coloured version pls. consider the price of the highest category of fabrics

Schienale mix da cm 75 senza cerniera zip

Mix back cushion 75 without zip

Cod. ZM075



↔ 75cm ↘ 33cm ↓ 35cm
📦 0,13 m³ ⚖ 16kg 🌀 0,8mt

Schienale mix da cm 105 senza cerniera zip

Mix back cushion 105 without zip

Cod. ZM105



↔ 105cm ↘ 33cm ↓ 35cm
📦 0,17 m³ ⚖ 16kg 🌀 0,8mt

Papilo cuscini schienale - *Papilo back cushions*

Cuscino "fantasmino"

Low-cut cushion

Cod. PAPIZCS01



↔ 75cm ↘ 62cm ↓ 40cm
☞ 0,4 m³ ⚖ 8kg ⚙ 2mt

Cuscino "fantasmino" grande

Large low-cut cushion

Cod. PAPIZCS02



↔ 94cm ↘ 62cm ↓ 40cm
☞ 0,4 m³ ⚖ 8kg ⚙ 2,3mt

Cuscino schienale

Back cushion

Cod. PAPIZH100



↔ 103cm ↘ 44cm ↓ 39cm
☞ 0,17 m³ ⚖ 14kg ⚙ 1,8mt

Cuscino schienale angolare

Corner back cushion

Cod. PAPIZHA60



↔ 124cm ↘ 44-72cm ↓ 39cm
☞ 0,43 m³ ⚖ 28kg ⚙ 2,4mt

Sanders cuscini - Sanders cushions

C1 cuscino schienale a scatola in piuma con Zip 55x55

C1 Back scatter cushion with zip 55x55

Cod. ZC0C1



↔ 55cm ↘ 15cm ↓ 55cm
☞ 0,06 m³ ⚖ 2kg ⚡ 0,9mt

Cerniera beige (CE01) o grigio (CE03)
Zip available in colours beige (CE01) or gray (CE03)

H5 cuscino in piuma a scatola 45x36

H5 Feather scatter cushion 45x36

Cod. ZC0H5



↔ 45cm ↘ 15cm ↓ 36cm
☞ 0,03 m³ ⚖ 0,5kg ⚡ 0,7mt

C2 cuscino a scatola in piuma con Zip 45x45

C2 Scatter cushion with Zip 45x45

Cod. ZC0C2



↔ 45cm ↘ 15cm ↓ 45cm
☞ 0,04 m³ ⚖ 1,5kg ⚡ 0,7mt

Cerniera beige (CE01) o grigio (CE03)
Zip available in colours beige (CE01) or gray (CE03)

C6 cuscino tondo in piuma con Zip diam.50

C6 Feather rounded cushion with Zip diam. 50

Cod. ZC0C6



↔ 50cm ↘ 15cm ↓ 50cm
☞ 0,05 m³ ⚖ 1,5kg ⚡ 0,9mt

Cerniera beige (CE01) o grigio (CE03)
Zip available in colours beige (CE01) or gray (CE03)

H3 cuscino in piuma a saponetta 45x35

L3 Feather scatter cushion 45x35

Cod. ZC0H3



↔ 45cm ↘ 15cm ↓ 35cm
☞ 0,02 m³ ⚖ 0,7kg ⚡ 0,6mt

H4 cuscino in piuma a saponetta 50x25

H4 Feather scatter cushion 50x25

Cod. ZC0H4



↔ 50cm ↘ 15cm ↓ 25cm
☞ 0,02 m³ ⚖ 1kg ⚡ 0,6mt

Cuscino bracciolo

Armcushion

Cod. ZCB10



↔ 40cm ↘ 70cm ↓ 16cm
☞ 0,05 m³ ⚖ 3kg ⚡ 1,0mt

Sanders composizioni con schienali con cerniera zip - Sanders compositions with back cushions with zip

Composizione

Composition

Cod. K0001

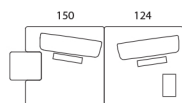

↔ 274cm ↘ 124cm ↓ 73cm
 ☐ 2,17 m³ ⚖ 128kg ⚡ 10,7mt+3,9mt

Per finitura bicolore prezzo della categoria più alta dei rivestimenti utilizzati.
 For the two-coloured version pls. consider the price of the highest category of fabrics

Composizione

Composition

Cod. K0005

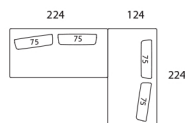

↔ 348cm ↘ 224cm ↓ 73cm
 ☐ 3,24 m³ ⚖ 180kg ⚡ 13,4mt+5,1mt

Per finitura bicolore prezzo della categoria più alta dei rivestimenti utilizzati.
 For the two-coloured version pls. consider the price of the highest category of fabrics

Composizione

Composition

Cod. K0002

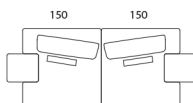

↔ 300cm ↘ 124cm ↓ 73cm
 ☐ 2,26 m³ ⚖ 132kg ⚡ 11,4mt+4,3mt

Per finitura bicolore prezzo della categoria più alta dei rivestimenti utilizzati.
 For the two-coloured version pls. consider the price of the highest category of fabrics

Composizione

Composition

Cod. K0006

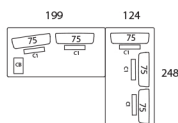

↔ 323cm ↘ 248cm ↓ 73cm
 ☐ 3,66 m³ ⚖ 201kg ⚡ 20,1mt+5,7mt

Per finitura bicolore prezzo della categoria più alta dei rivestimenti utilizzati.
 For the two-coloured version pls. consider the price of the highest category of fabrics

Composizione

Composition

Cod. K0003

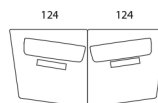

↔ 248cm ↘ 124cm ↓ 73cm
 ☐ 2,24 m³ ⚖ 109kg ⚡ 8,5mt+3,5mt

Per finitura bicolore prezzo della categoria più alta dei rivestimenti utilizzati.
 For the two-coloured version pls. consider the price of the highest category of fabrics

Composizione

Composition

Cod. K0007

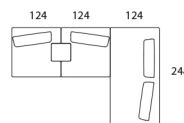

↔ 372cm ↘ 248cm ↓ 73cm
 ☐ 3,87 m³ ⚖ 223kg ⚡ 15,1mt+7,4mt

Per finitura bicolore prezzo della categoria più alta dei rivestimenti utilizzati.
 For the two-coloured version pls. consider the price of the highest category of fabrics

Composizione

Composition

Cod. K0004

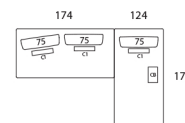

↔ 298cm ↘ 174cm ↓ 73cm
 ☐ 2,67 m³ ⚖ 146kg ⚡ 15,2mt+5,1mt

Per finitura bicolore prezzo della categoria più alta dei rivestimenti utilizzati.
 For the two-coloured version pls. consider the price of the highest category of fabrics

Composizione

Composition

Cod. K0008

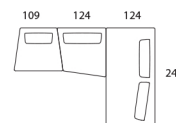

↔ 357cm ↘ 248cm ↓ 73cm
 ☐ 3,92 m³ ⚖ 203kg ⚡ 13,3mt+6,6mt

Per finitura bicolore prezzo della categoria più alta dei rivestimenti utilizzati.
 For the two-coloured version pls. consider the price of the highest category of fabrics

Sanders composizioni con schienali con cerniera zip - Sanders compositions with back cushions with zip

Composizione

Composition

Cod. K0009

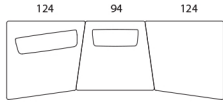

↔ 342cm ↘ 124cm ↓ 73cm

📦 2,92 m³ ⚖️ 134kg 📏 8,4mt+5,2mt

Per finitura bicolore prezzo della categoria più alta dei rivestimenti utilizzati.
For the two-coloured version pls. consider the price of the highest category of fabrics

Composizione

Composition

Cod. K0010

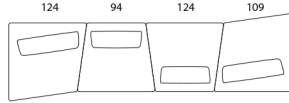

↔ 451cm ↘ 124cm ↓ 73cm

📦 4,14 m³ ⚖️ 199kg 📏 13,2mt+6,9mt

Per finitura bicolore prezzo della categoria più alta dei rivestimenti utilizzati.
For the two-coloured version pls. consider the price of the highest category of fabrics